



# Kraus & Naimer

BLUE LINE switchgear

since 1907

Disconnectors for

*Photovoltaic*

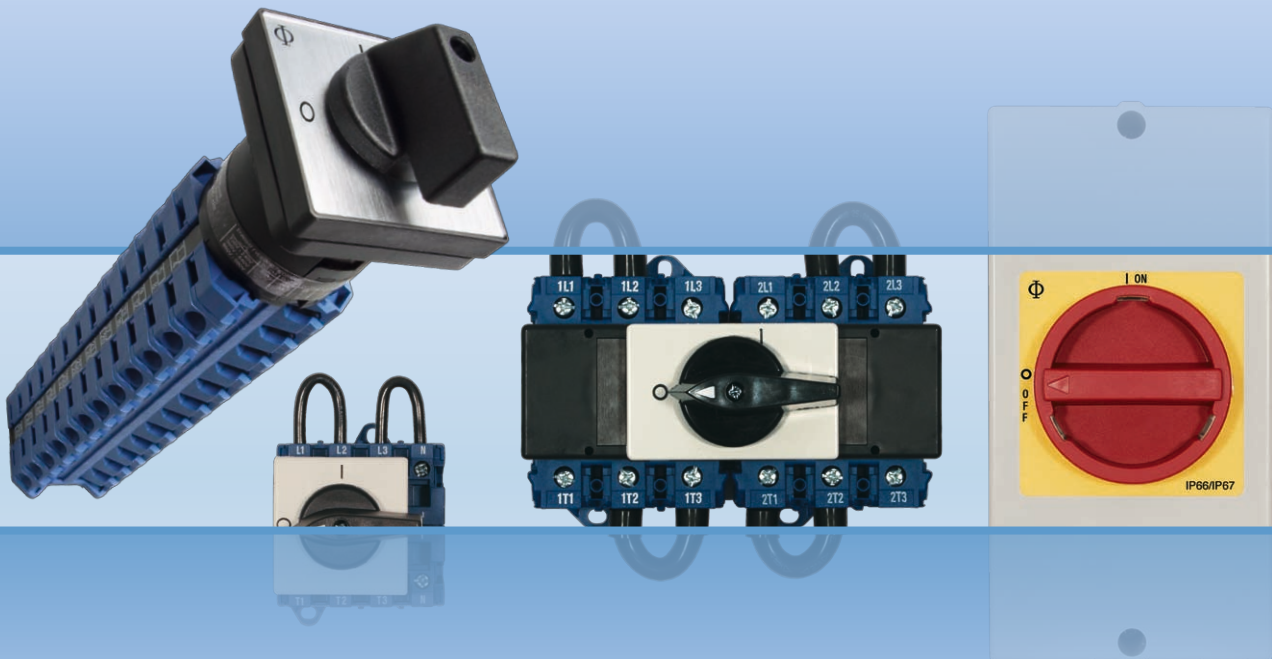

next ▶

Kraus & Naimer

*SYSTEM VARIANTS*

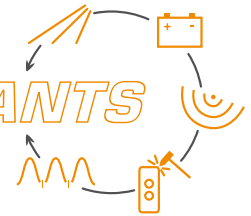

Ask for your free EMC-Catalog now!

Maintenance Switches for

***EMC-compliant connection***



We are focused  
on the solution

Since 1907 Kraus & Naimer has produced low-voltage switchgear. We developed the world's first modular rotary cam switches and are the undisputed market leader of rotary cam switches world wide. Our product line is designed to fit the needs of a global marketplace. We offer quality, variety, the latest technology, superior customer service, along with economy and quick deliveries.

next ►



Disconnectors for

# Photovoltaic

Please select the accurate switch disconnecter according to the power performance of your Photovoltaic application.

< For direct link click on the page number >

Contact development: 1 x 2 pole			
Rated Operational		Screw / Snap on Base Mounting	In Enclosure
Voltage	Current	Page	Page
450 V	16 A	4	9
	25 A	4	9
	32 A	4	9
500 V	12 A	4	9
	20 A	4	9
	32 A	5	10
650 V	16 A	5	10
	25 A	5	10
	32 A	5	10
	63 A	7	12
800 V	12 A	5	10
	16 A	6	11
	25 A	6	11
	32 A	6	11
	64 A	8	12

Contact development: 1 x 2 pole, 2 x 2 pole and 3 x 2 pole		
Rated Operational		Panel Mounting
Voltage	Current	Page
500 V	20 A	13
750 V	20 A	14
1000 V	20 A	15
Contact	16	



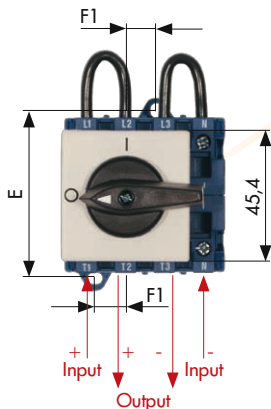
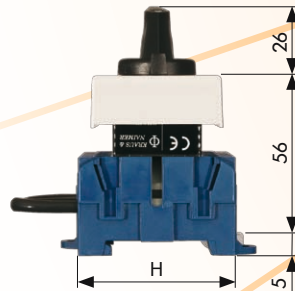

Note: UL - approved switches on request

DC Disconnectors for Solar Photovoltaic (PV) Power Supply System  
acc. to IEC 60364-7-712:2002

Disconnectors for  
**Photovoltaic**

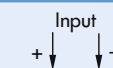

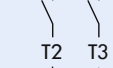
	KG20A/ KG32A	KG41
A	43,7	52,4
E	60	70
F1	11	12,5
G	55,5	66
H	54	64

Connecting diagram	Tightening torque for terminal screws	Strip length
	KG20A/ KG32A 1,25 Nm	KG20A/ KG32A 9 
	KG41 1,80 Nm	KG41 10 

**Contact development: 2 pole, 4 contacts per circuit (2 x 2 in series)**

### General Data

Switch Disconnecter according to EN 60947-3 respectively VDE 0660 Part 107  
Utilization Category: DC-22 A for Photovoltaic Application and for continuous switching  
Ambient Temperature (open): 50 °C during 24 hours with peaks up to 55 °C  
Terminal Lugs finger-proof according to VDE 0660-514 and BGV A3, IP 20

Maximum permissible wire gage (use copper wire only)  
single core wire or stranded wire  
flexible wire

KG20A / KG32A: 6 mm <sup>2</sup>	KG41: 16 mm <sup>2</sup>
KG20A / KG32A: 4 mm <sup>2</sup>	KG41: 10 mm <sup>2</sup>

### Mounting

Screw/Snap on base mounting for track EN 60715  
Escutcheon plate for 45 mm standard knock-out, F-handle black

### Rated Value / Order Number

	16 A	25 A	32 A
<b>Operational Current</b>	<b>16 A</b>	<b>25 A</b>	<b>32 A</b>
<b>Operational Voltage</b>	<b>450 V DC</b>	<b>450 V DC</b>	<b>450 V DC</b>
Max. Off load voltage of the PV inverter	520 V DC	520 V DC	520 V DC
Insulation Voltage	690 V	690 V	690 V
<b>Operational Current</b>	<b>12 A</b>	<b>20 A</b>	
<b>Operational Voltage</b>	<b>500 V DC</b>	<b>500 V DC</b>	
Max. Off load voltage of the PV inverter	575 V DC	575 V DC	
Insulation Voltage	690 V	690 V	
<b>Order Number</b>	<b>KG20A T304/D-P001 VE2</b>	<b>KG32A T304/D-P001 VE2</b>	<b>KG41 T304/D-P001 VE2</b>



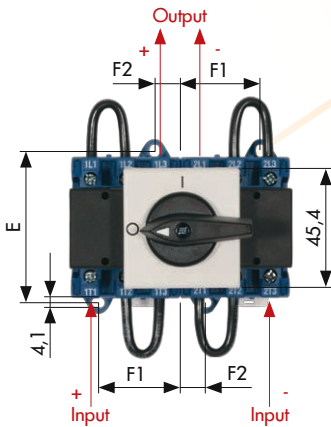
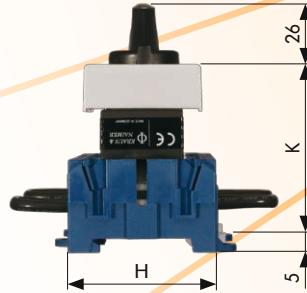

Data valid only, if the pre-assembled jumpers have not been modified.

DC Disconnectors for Solar Photovoltaic (PV) Power Supply System  
acc. to IEC 60364-7-712:2002

Disconnectors for  
**Photovoltaic**

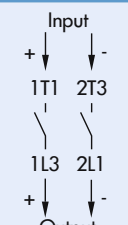

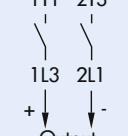
	KG20A/ KG32A	KG41B
A	43,7	105,4
E	60	70
F1	32	37,5
F2	10	12,5
G	84	100
H	54	64
K	64	62,5

Connecting diagram	Tightening torque for terminal screws	Strip length
	KG20A/ KG32A 1,25 Nm	KG20A/ KG32A 9 
	KG41B 1,80 Nm	KG41B 10 

**Contact development: 2 pole, 6 contacts per circuit (2 x 3 in series)**

**General Data**

Switch Disconnecter according to EN 60947-3 respectively VDE 0660 Part 107  
Utilization Category: DC-22 A for Photovoltaic Application and for continuous switching  
Ambient Temperature (open): 50 °C during 24 hours with peaks up to 55 °C  
Terminal Lugs finger-proof according to VDE 0660-514 and BGV A3, IP 20

Maximum permissible wire gage (use copper wire only)  
single core wire or stranded wire  
flexible wire

KG20A/ KG32A: 6 mm <sup>2</sup>	KG41B: 16 mm <sup>2</sup>
KG20A/ KG32A: 4 mm <sup>2</sup>	KG41B: 10 mm <sup>2</sup>

**Mounting**

Screw/Snap on base mounting for track EN 60715  
Escutcheon plate for 45 mm standard knock-out, F-handle black

**Rated Value / Order Number**

	16 A	32 A	32 A
<b>Operational Current</b>	<b>16 A</b>	<b>32 A</b>	<b>32 A</b>
<b>Operational Voltage</b>	<b>650 V DC</b>	<b>500 V DC</b>	<b>650 V DC</b>
Max. Off load voltage of the PV inverter	750 V DC	575 V DC	750 V DC
Insulation Voltage	1000 V	1000 V	1000 V
<b>Operational Current</b>	<b>12 A</b>	<b>25 A</b>	
<b>Operational Voltage</b>	<b>800 V DC</b>	<b>650 V DC</b>	
Max. Off load voltage of the PV inverter	920 V DC	750 V DC	
Insulation Voltage	1000 V	1000 V	
<b>Order Number</b>	<b>KG20A T306/D-P001 VE2</b>	<b>KG32A T306/D-P001 VE2</b>	<b>KG41B T306/D-P001 VE2</b>



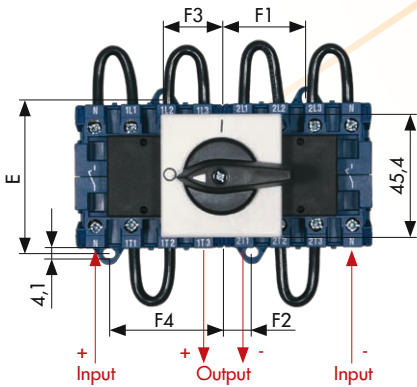
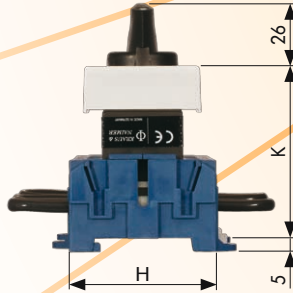
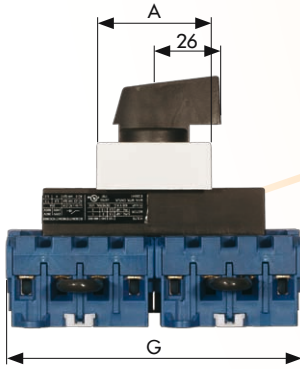

Data valid only, if the pre-assembled jumpers have not been modified.

DC Disconnectors for Solar Photovoltaic (PV) Power Supply System  
acc. to IEC 60364-7-712:2002

Disconnectors for  
**Photovoltaic**



	KG20A/ KG32A	KG41B
A	43,7	105,4
E	60	70
F1	32	37,5
F2	10	12,5
F3	23,5	28,5
F4	45,5	53,5
G	111	132
H	54	64
K	64	62,5

Connecting diagram	Tightening torque for terminal screws	Strip length
	KG20A/ KG32A 1,25 Nm	KG20A/ KG32A 9 
	KG41B 1,80 Nm	KG41B 10 

**Contact development: 2 pole, 8 contacts per circuit (2 x 4 in series)**

Back to the table of contents >

**General Data**

Switch Disconnecter according to EN 60947-3 respectively VDE 0660 Part 107  
Utilization Category: DC-22 A for Photovoltaic Application and for continuous switching  
Ambient Temperature (open): 50 °C during 24 hours with peaks up to 55 °C  
Terminal Lugs finger-proof according to VDE 0660-514 and BGV A3, IP 20  
Maximum permissible wire gage (use copper wire only)  
single core wire or stranded wire      KG20A / KG32A: 6 mm<sup>2</sup>      KG41B: 16 mm<sup>2</sup>  
flexible wire                                      KG20A / KG32A: 4 mm<sup>2</sup>      KG41B: 10 mm<sup>2</sup>

**Mounting**

Screw/Snap on base mounting for track EN 60715  
Escutcheon plate for 45 mm standard knock-out, F-handle black

**Rated Value / Order Number**

	16 A	25 A	32 A
<b>Operational Current</b>	<b>16 A</b>	<b>25 A</b>	<b>32 A</b>
<b>Operational Voltage</b>	<b>800 V DC</b>	<b>800 V DC</b>	<b>800 V DC</b>
Max. Off load voltage of the PV inverter	920 V DC	920 V DC	920 V DC
Insulation Voltage	1000 V	1000 V	1000 V

Order Number	KG20A T308/D-P001 VE2	KG32A T308/D-P001 VE2	KG41B T308/D-P001 VE2
--------------	-----------------------	-----------------------	-----------------------

Data valid only, if the pre-assembled jumpers have not been modified.



DC Disconnectors for Solar Photovoltaic (PV) Power Supply System  
acc. to IEC 60364-7-712:2002

Disconnectors for  
**Photovoltaic**

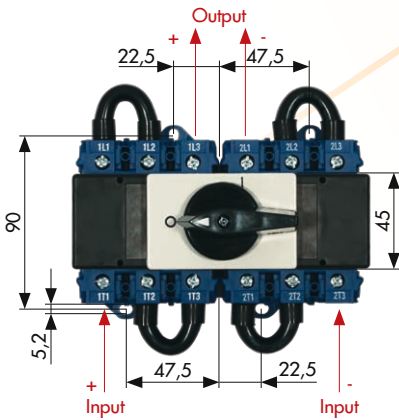
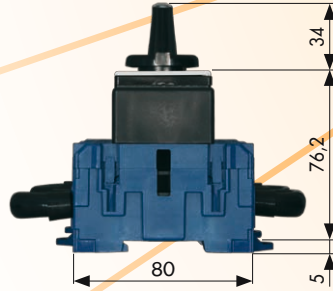
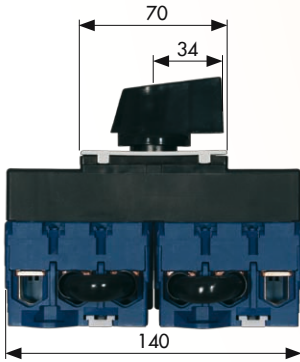

Connecting diagram	Tightening torque for terminal screws	Strip length
	KG80 3,00 Nm	KG80 14

**Contact development: 2 pole, 6 contacts per circuit (2 x 3 in series)**

**General Data**

Switch Disconnecter according to EN 60947-3 respectively VDE 0660 Part 107  
Utilization Category: DC-22 A for Photovoltaic Application and for continuous switching  
Ambient Temperature (open): 50 °C during 24 hours with peaks up to 55 °C  
Terminal Lugs finger-proof according to VDE 0660-514 and BGV A3, IP 20  
Maximum permissible wire gage (use copper wire only)  
single core wire or stranded wire 50 mm<sup>2</sup>  
flexible wire 35 mm<sup>2</sup>

**Mounting**

Screw/Snap on base mounting for track EN 60715  
Escutcheon plate for 45 mm standard knock-out, F-handle black

**Rated Value / Order Number**

<b>Operational Current</b>	<b>63 A</b>
<b>Operational Voltage</b>	<b>650 V DC</b>
Max. Off load voltage of the PV inverter	750 V DC
Insulation Voltage	1000 V

**Order Number** **KG80 T306/D-P001 VE2**

Data valid only, if the pre-assembled jumpers have not been modified.

DC Disconnectors for Solar Photovoltaic (PV) Power Supply System  
acc. to IEC 60364-7-712:2002

Disconnectors for  
**Photovoltaic**

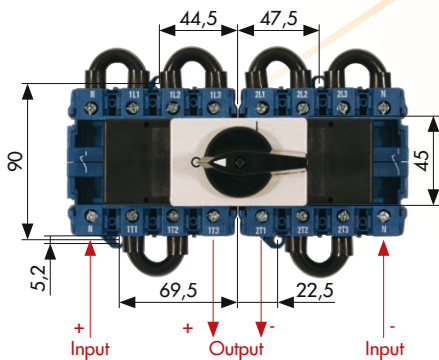
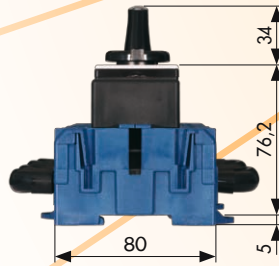
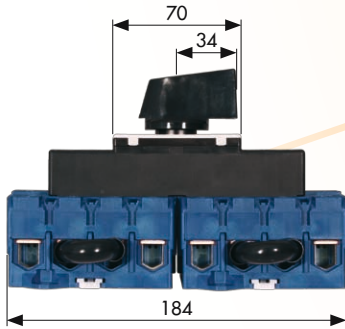

Connecting diagram	Tightening torque for terminal screws	Strip length
	KG80 3,00 Nm	KG80 14 

**Contact development: 2 pole, 8 contacts per circuit (2 x 4 in series)**

**General Data**

Switch Disconnecter according to EN 60947-3 respectively VDE 0660 Part 107  
Utilization Category: DC-22 A for Photovoltaic Application and for continuous switching  
Ambient Temperature (open): 50 °C during 24 hours with peaks up to 55 °C  
Terminal Lugs finger-proof according to VDE 0660-514 and BGV A3, IP 20  
Maximum permissible wire gage (use copper wire only)  
single core wire or stranded wire 50 mm<sup>2</sup>  
flexible wire 35 mm<sup>2</sup>

**Mounting**

Screw/Snap on base mounting for track EN 60715  
Escutcheon plate for 45 mm standard knock-out, F-handle black

**Rated Value / Order Number**

<b>Operational Current</b>	<b>64 A</b>
<b>Operational Voltage</b>	<b>800 V DC</b>
Max. Off load voltage of the PV inverter	920 V DC
Insulation Voltage	1000 V

**Order Number** **KG80 T308/D-P001 VE2**

Data valid only, if the pre-assembled jumpers have not been modified.

Back to the table of contents >





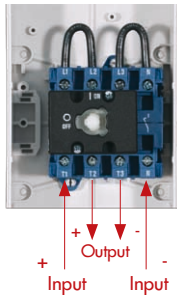
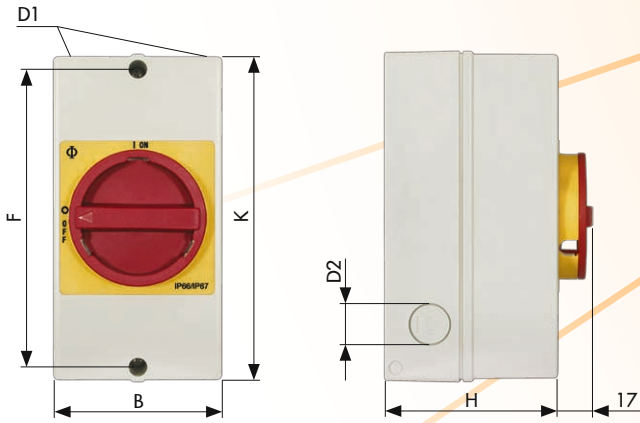

DC Disconnectors for Solar Photovoltaic (PV) Power Supply System  
acc. to IEC 60364-7-712:2002

Disconnectors for  
**Photovoltaic**

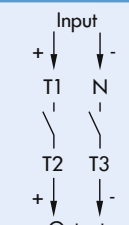

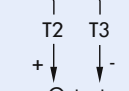
	KG20 / KG32	KG41
B	85	100
D1	2 x Ø 20	2 x Ø 25
D2	Ø 20	Ø 25
F	150	178
H	82	93
K	160	190

Connecting diagram	Tightening torque for terminal screws	Strip length
	KG20 / KG32 1,25 Nm	KG20 / KG32 9 
	KG41 1,80 Nm	KG41 10 

**Contact development: 2 pole, 4 contacts per circuit (2 x 2 in series)**

**General Data**

Switch Disconnector according to EN 60947-3 respectively VDE 0660 Part 107  
Utilization Category: DC-22 A for Photovoltaic Application and for continuous switching  
Ambient Temperature (open): 50 °C during 24 hours with peaks up to 55 °C  
Terminal Lugs finger-proof according to VDE 0660-514 and BGV A3, IP 20

Maximum permissible wire gage (use copper wire only)  
single core wire or stranded wire  
flexible wire

KG20 / KG32: 6 mm <sup>2</sup>	KG41: 16 mm <sup>2</sup>
KG20 / KG32: 4 mm <sup>2</sup>	KG41: 10 mm <sup>2</sup>

**Mounting**

Plastic Enclosures, Protection IP66/67, totally insulated, knock-out entries,  
Red handle and contrasting yellow escutcheon plate, OFF-position lockable with padlocks, cover coupling with interlock

**Rated Value / Order Number**

	16 A	25 A	32 A
<b>Operational Current</b>	<b>16 A</b>	<b>25 A</b>	<b>32 A</b>
<b>Operational Voltage</b>	<b>450 V DC</b>	<b>450 V DC</b>	<b>450 V DC</b>
Max. Off load voltage of the PV inverter	520 V DC	520 V DC	520 V DC
Insulation Voltage	690 V	690 V	690 V
<b>Operational Current</b>	<b>12 A</b>	<b>20 A</b>	
<b>Operational Voltage</b>	<b>500 V DC</b>	<b>500 V DC</b>	
Max. Off load voltage of the PV inverter	575 V DC	575 V DC	
Insulation Voltage	690 V	690 V	
<b>Order Number</b>	<b>KG20 T204/D-P003 KL51V</b>	<b>KG32 T204/D-P003 KL51V</b>	<b>KG41 T204/D-P003 KL11V</b>



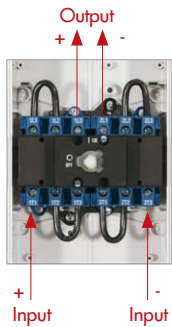
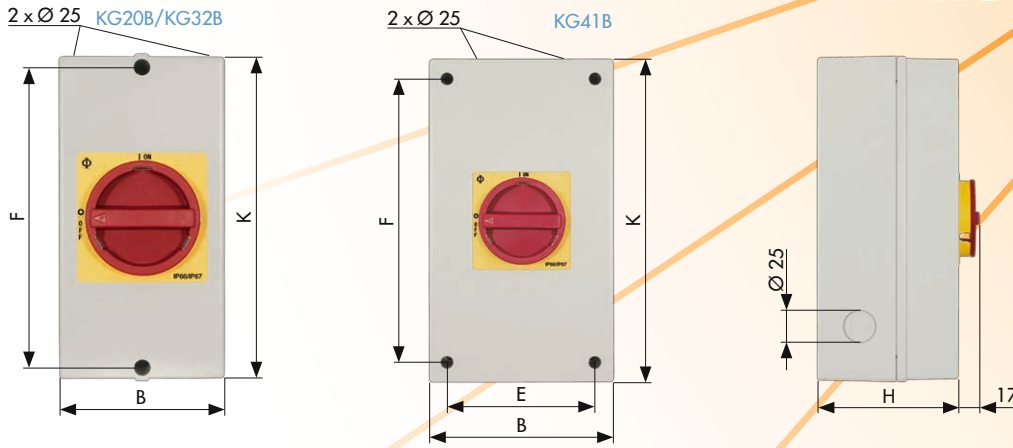

Data valid only, if the pre-assembled jumpers have not been modified.

DC Disconnectors for Solar Photovoltaic (PV) Power Supply System  
acc. to IEC 60364-7-712:2002

Disconnectors for  
**Photovoltaic**

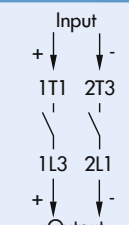

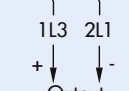
	KG20B/ KG32B	KG41B
B	100	145
E	—	124
F	178	229
H	93	107
K	190	250

Connecting diagram	Tightening torque for terminal screws	Strip length
	KG20B/ KG32B 1,25 Nm	KG20B/ KG32B 9 
	KG41B 1,80 Nm	KG41B 10 

Contact development: 2 pole, 6 contacts per circuit (2 x 3 in series)

**General Data**

Switch Disconnector according to EN 60947-3 respectively VDE 0660 Part 107  
Utilization Category: DC-22 A for Photovoltaic Application and for continuous switching  
Ambient Temperature (open): 50 °C during 24 hours with peaks up to 55 °C (KG32B from 26 A: 35 °C during 24 hours with peaks up to 40 °C)  
Terminal Lugs finger-proof according to VDE 0660-514 and BGV A3, IP 20  
Maximum permissible wire gage (use copper wire only)  
single core wire or stranded wire  
flexible wire

KG20B / KG32B: 6 mm <sup>2</sup>	KG41B: 16 mm <sup>2</sup>
KG20B / KG32B: 4 mm <sup>2</sup>	KG41B: 10 mm <sup>2</sup>

**Mounting**

Plastic Enclosures, Protection IP66/67, totally insulated, knock-out entries,  
Red handle and contrasting yellow escutcheon plate, OFF-position lockable with padlocks, cover coupling with interlock

**Rated Value / Order Number**

	16 A	32 A	32 A
<b>Operational Current</b>	<b>16 A</b>	<b>32 A</b>	<b>32 A</b>
<b>Operational Voltage</b>	<b>650 V DC</b>	<b>500 V DC</b>	<b>650 V DC</b>
Max. Off load voltage of the PV inverter	750 V DC	575 V DC	750 V DC
Insulation Voltage	1000 V	1000 V	1000 V
<b>Operational Current</b>	<b>12 A</b>	<b>25 A</b>	
<b>Operational Voltage</b>	<b>800 V DC</b>	<b>650 V DC</b>	
Max. Off load voltage of the PV inverter	920 V DC	750 V DC	
Insulation Voltage	1000 V	1000 V	
<b>Order Number</b>	<b>KG20B T206/D-P003 KL11V</b>	<b>KG32B T206/D-P003 KL11V</b>	<b>KG41B T206/D-P003 KL11V</b>





Data valid only, if the pre-assembled jumpers have not been modified.

Back to the table of contents >

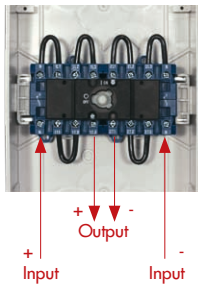
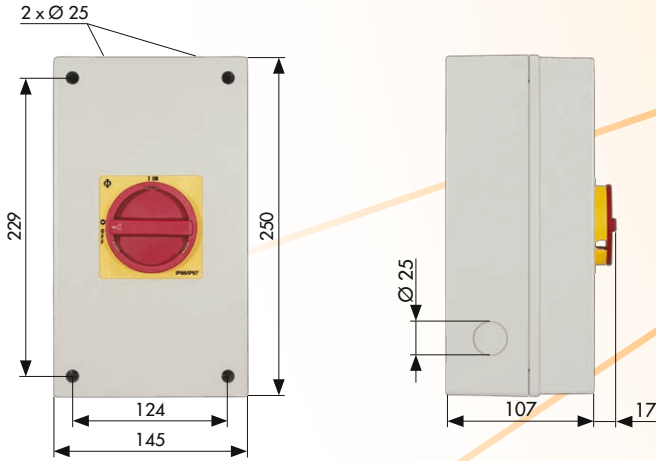
DC Disconnectors for Solar Photovoltaic (PV) Power Supply System  
acc. to IEC 60364-7-712:2002

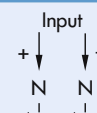
Disconnectors for  
**Photovoltaic**



Connecting diagram	Tightening torque for terminal screws	Strip length
	KG20B/ KG32B	1,25 Nm
	KG41B	1,80 Nm
		KG20B/ KG32B: 9  KG41B: 10 

**Contact development: 2 pole, 8 contacts per circuit (2 x 4 in series)**

**General Data**

Switch Disconnector according to EN 60947-3 respectively VDE 0660 Part 107  
Utilization Category: DC-22 A for Photovoltaic Application and for continuous switching  
Ambient Temperature (open): 50 °C during 24 hours with peaks up to 55 °C  
Terminal Lugs finger-proof according to VDE 0660-514 and BGV A3, IP 20

Maximum permissible wire gage (use copper wire only)  
single core wire or stranded wire      KG20B / KG32B: 6 mm<sup>2</sup>      KG41B: 16 mm<sup>2</sup>  
flexible wire      KG20B / KG32B: 4 mm<sup>2</sup>      KG41B: 10 mm<sup>2</sup>

**Mounting**

Plastic Enclosures, Protection IP66/67, totally insulated, knock-out entries,  
Red handle and contrasting yellow escutcheon plate, OFF-position lockable with padlocks, cover coupling with interlock

**Rated Value / Order Number**

	<b>16 A</b>	<b>25 A</b>	<b>32 A</b>
<b>Operational Current</b>	<b>16 A</b>	<b>25 A</b>	<b>32 A</b>
<b>Operational Voltage</b>	<b>800 V DC</b>	<b>800 V DC</b>	<b>800 V DC</b>
Max. Off load voltage of the PV inverter	920 V DC	920 V DC	920 V DC
Insulation Voltage	1000 V	1000 V	1000 V

**Order Number**      **KG20B T208/D-P003 KL11V**      **KG32B T208/D-P003 KL11V**      **KG41B T208/D-P003 KL11V**

Data valid only, if the pre-assembled jumpers have not been modified.

DC Disconnectors for Solar Photovoltaic (PV) Power Supply System  
acc. to IEC 60364-7-712:2002

Disconnectors for  
**Photovoltaic**

**650 V DC**

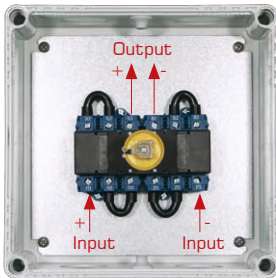

**Contact development: 2 pole**  
6 contacts per circuit (2 x 3 in series)

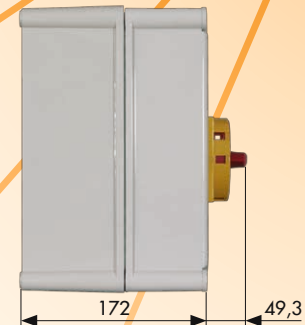
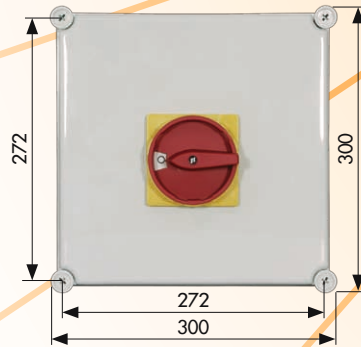

**800 V DC**

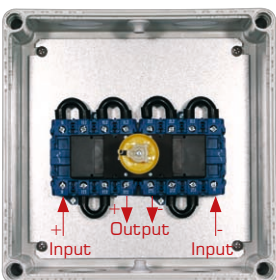

**Contact development: 2 pole**  
8 contacts per circuit (2 x 4 in series)

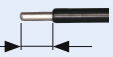
Connecting diagram 6 contacts	Connecting diagram 8 contacts	Tightening torque for terminal screws	Strip length
<pre>           Input           +   -                           1T1 2T3   1L3 2L1                           +   -           Output         </pre>	<pre>           Input           +   -                           N   N   1T3 2T1                           +   -           Output         </pre>	KG80C 3,00 Nm	KG80C 14 

Back to the table of contents >

**General Data**

Switch Disconnecter according to EN 60947-3 respectively VDE 0660 Part 107  
Utilization Category: DC-22 A for Photovoltaic Application and for continuous switching  
Ambient Temperature (open): 50 °C during 24 hours with peaks up to 55 °C  
Terminal Lugs finger-proof according to VDE 0660-514 and BGV A3, IP 20  
Maximum permissible wire gage (use copper wire only)  
single core wire or stranded wire 50 mm<sup>2</sup>  
flexible wire 35 mm<sup>2</sup>

**Mounting**

Plastic Enclosures, Protection IP66/67, totally insulated, without entries  
Red handle and contrasting yellow escutcheon plate, OFF-position lockable with padlocks, cover coupling with interlock

**Rated Value / Order Number**

	<b>63 A</b>	<b>64 A</b>
<b>Operational Current</b>	<b>63 A</b>	<b>64 A</b>
<b>Operational Voltage</b>	<b>650 V DC</b>	<b>800 V DC</b>
Max. Off load voltage of the PV inverter	750 V DC	920 V DC
Insulation Voltage	1000 V	1000 V
<b>Order Number</b>	<b>KG80C T206/D-P003 STM</b>	<b>KG80C T208/D-P003 STM</b>

Data valid only, if the pre-assembled jumpers have not been modified.



DC Disconnectors for Solar Photovoltaic (PV) Power Supply System  
acc. to IEC 60364-7-712:2002

Disconnectors for  
**Photovoltaic**

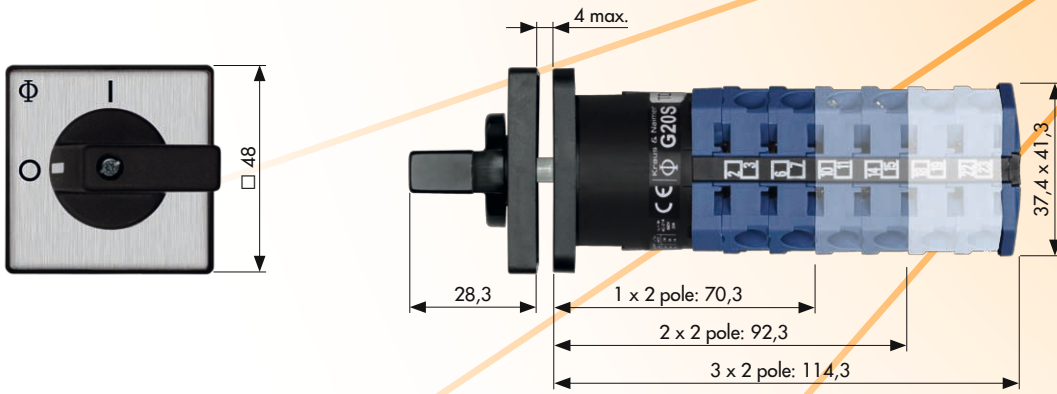

Drilling plan	Tightening torque for terminal screws	
	G20S	0,8 Nm
	<b>Strip length</b>	
	G20S	8

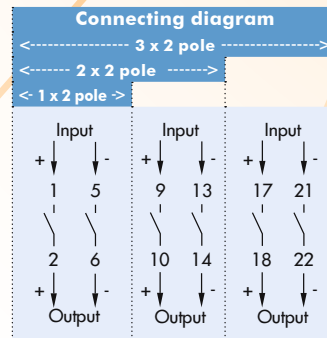

**Contact development: 1 x 2 pole, 2 x 2 pole and 3 x 2 pole**

**General Data**

Switch Disconnecter according to EN 60947-3 respectively VDE 0660 Part 107  
 Utilization Category: DC-22 A for Photovoltaic Application  
 Ambient Temperature (open): 55 °C during 24 hours, 65 °C during 8 hours  
 Terminal Lugs finger-proof according to VDE 0660-514 and BGV A3, IP 20  
 Maximum permissible wire gage (use copper wire only)  
 single core wire or stranded wire      2 x 2,5 mm<sup>2</sup>  
 flexible wire      2 x 2,5 mm<sup>2</sup>

**Mounting**

Four hole panel mounting, panel thickness max. 4 mm,  
 Escutcheon Plate Backing brushed alu, standard handle

**Rated Value / Order Number**

	1 x 2 pole	2 x 2 pole	3 x 2 pole
<b>Operational Current</b>	<b>20 A</b>	<b>20 A</b>	<b>20 A</b>
<b>Operational Voltage</b>	<b>500 V DC</b>	<b>500 V DC</b>	<b>500 V DC</b>
Max. Off load voltage of the PV inverter	630 V DC	630 V DC	630 V DC
Insulation Voltage	630 V	630 V	630 V
<b>Order Number</b>	<b>G20S TD3102 E</b>	<b>G20S TD3104 E</b>	<b>G20S TD3106 E</b>

Data valid only, if the pre-assembled jumpers have not been modified.

Back to the table of contents >

DC Disconnectors for Solar Photovoltaic (PV) Power Supply System  
acc. to IEC 60364-7-712:2002

Disconnectors for  
**Photovoltaic**

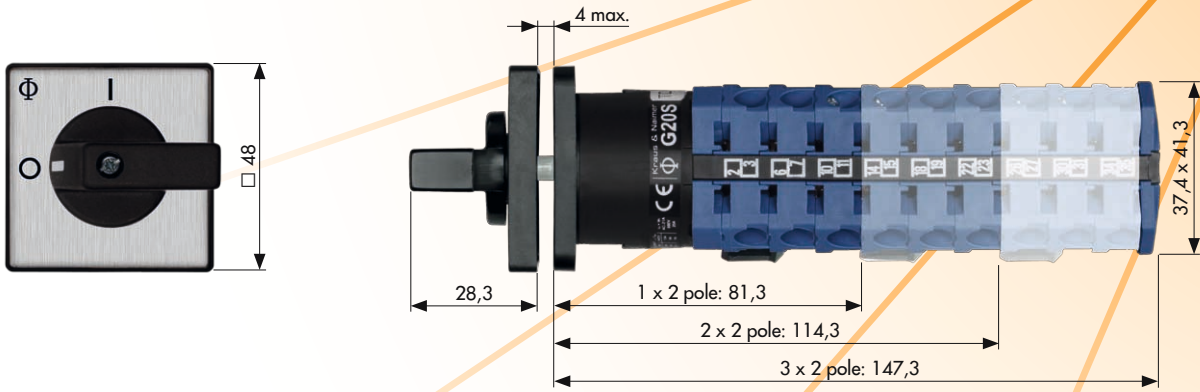

Drilling plan	Tightening torque for terminal screws	
	G20S	0,8 Nm
	Strip length	
	G20S	8

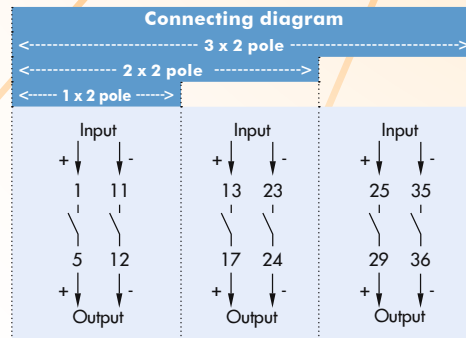

**Contact development: 1 x 2 pole, 2 x 2 pole and 3 x 2 pole**

**General Data**

Switch Disconnector according to EN 60947-3 respectively VDE 0660 Part 107  
 Utilization Category: DC-22 A for Photovoltaic Application  
 Ambient Temperature (open): 55 °C during 24 hours, 65 °C during 8 hours  
 Terminal Lugs finger-proof according to VDE 0660-514 and BGV A3, IP 20  
 Maximum permissible wire gage (use copper wire only)  
 single core wire or stranded wire      2 x 2,5 mm<sup>2</sup>  
 flexible wire      2 x 2,5 mm<sup>2</sup>

**Mounting**

Four hole panel mounting, panel thickness max. 4 mm,  
 Escutcheon Plate Backing brushed alu, standard handle

**Rated Value / Order Number**

	1 x 2 pole	2 x 2 pole	3 x 2 pole
<b>Operational Current</b>	<b>20 A</b>	<b>20 A</b>	<b>20 A</b>
<b>Operational Voltage</b>	<b>750 V DC</b>	<b>750 V DC</b>	<b>750 V DC</b>
Max. Off load voltage of the PV inverter	1000 V DC	1000 V DC	1000 V DC
Insulation Voltage	1000 V	1000 V	1000 V
<b>Order Number</b>	<b>G20S TD3351 E</b>	<b>G20S TD3352 E</b>	<b>G20S TD3353 E</b>

Data valid only, if the pre-assembled jumpers have not been modified.

DC Disconnectors for Solar Photovoltaic (PV) Power Supply System  
acc. to IEC 60364-7-712:2002

Disconnectors for  
**Photovoltaic**

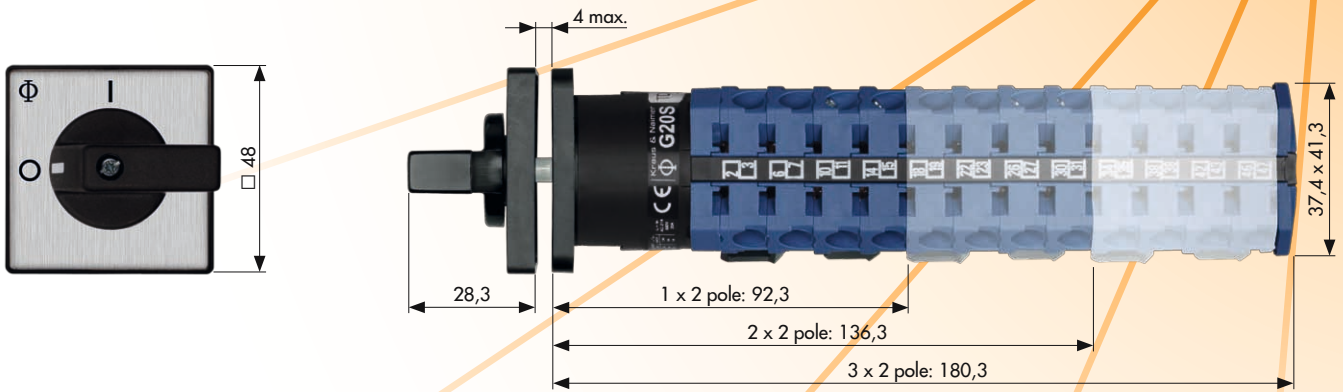

Drilling plan	Tightening torque for terminal screws	
	G20S	0,8 Nm
	<b>Strip length</b>	
	G20S	

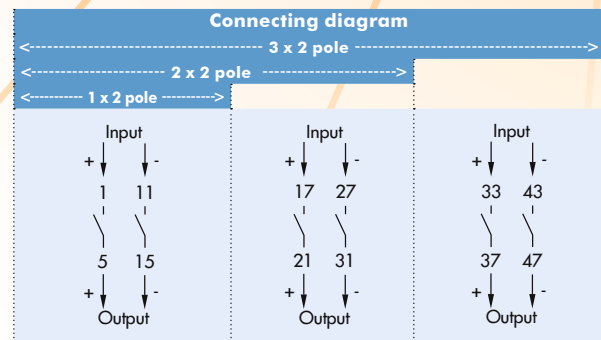

**Contact development: 1 x 2 pole, 2 x 2 pole and 3 x 2 pole**

**General Data**

Switch Disconnector according to EN 60947-3 respectively VDE 0660 Part 107  
Utilization Category: DC-22 A for Photovoltaic Application  
Ambient Temperature (open): 55 °C during 24 hours, 65 °C during 8 hours  
Terminal Lugs finger-proof according to VDE 0660-514 and BGV A3, IP 20  
Maximum permissible wire gage (use copper wire only)  
single core wire or stranded wire      2 x 2,5 mm<sup>2</sup>  
flexible wire      2 x 2,5 mm<sup>2</sup>

**Mounting**

Four hole panel mounting, panel thickness max. 4 mm,  
Escutcheon Plate Backing brushed alu, standard handle

**Rated Value / Order Number**

	1 x 2 pole	2 x 2 pole	3 x 2 pole
<b>Operational Current</b>	<b>20 A</b>	<b>20 A</b>	<b>20 A</b>
<b>Operational Voltage</b>	<b>1000 V DC</b>	<b>1000 V DC</b>	<b>1000 V DC</b>
Max. Off load voltage of the PV inverter	1000 V DC	1000 V DC	1000 V DC
Insulation Voltage	1000 V	1000 V	1000 V
<b>Order Number</b>	<b>G20S TD3202 E</b>	<b>G20S TD3204 E</b>	<b>G20S TD3206 E</b>

Data valid only, if the pre-assembled jumpers have not been modified.



**Kraus & Naimer**  
BLUE LINE switchgear

< Back to the table of contents >



EUROPARTNER-SOLAR GmbH & Co. KG  
Barbarastr. 31  
D-97074 Würzburg

Tel. +49 931-41 79 798 300  
Fax +49 931-41 79 798 307

[mail@europartner-solar.de](mailto:mail@europartner-solar.de)  
[www.europartner-solar.de](http://www.europartner-solar.de)